



Plasticade.com
Increase your visibility.



Compact Sign Stands



SSRB800 SS300 SS300A SS310 SS310A SS340A

High Mount Sign Stands

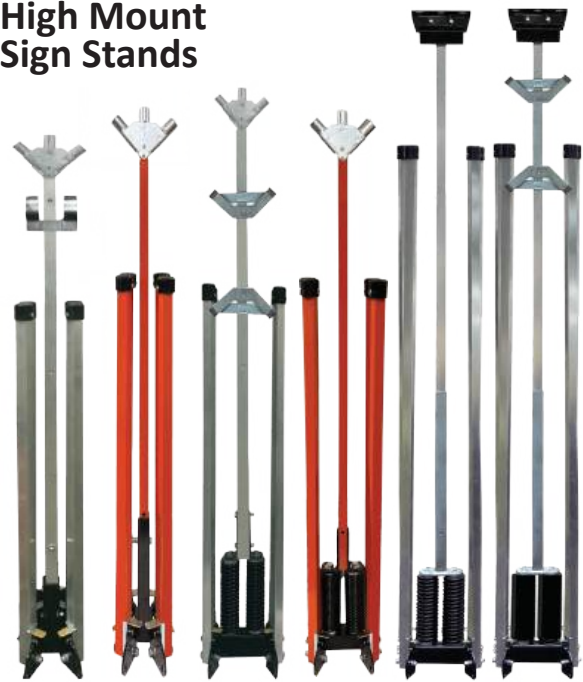

SS410A SS400 SS420A SS440 SS620A SS621A

Tripods & Barrier Mount Sign Stands



SS100 SS105 *BC-12 & BC-15

Sign Stand Index & Quick Guide

Model #	SSRB800	SS300	SS300A	SS310	SS310A	SS340A	SS400	SS410A	SS420A	SS440	SS620A	SS621A	SS100	SS105	BC-12 & BC-15
Roll-Up Sign	Yes	Yes	Yes	Yes	Yes	Yes	Yes	Yes	No	Yes	Yes	No	No	No	Yes
Rigid Sign	No	No	No	No	No	No	No	No	Yes .080 Alum.	Yes .080 Alum.	Yes 10 mm Cor.	Yes .080 Alum.	Yes 5/8" ply	Yes 5/8" ply	Yes
Main Material	Rubber	Powder Coated Steel	Alum.	Powder Coated Steel	Alum.	Alum.	Powder Coated Steel	Alum.	Alum.	Powder Coated Steel	Alum.	Alum.	Galv. Steel	Powder Coated Steel	Powder Coated Steel Clamp Alum. Mast
More Info.	Page 4	Page 3	Page 3	Page 3	Page 3	Page 4	Page 5	Page 5	Page 6	Page 6	Page 7	Page 8	Page 9	Page 9	Page 10

* BC-12 & BC-15 not MASH Tested



Roll-Up Sign Information on Page 13



LEG RELEASE SYSTEM

Legs lock in two positions to adjust to uneven ground

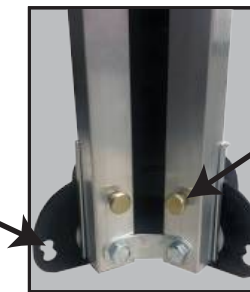

Pin Release



Step-on Leg Release

HEAVY DUTY SPRINGS

- Automotive grade springs
- designed to perform in extreme weather conditions without fatiguing or breaking
- E-coated for maximum rust and corrosion resistance
- Zinc plated nuts and bolts



SIGN HOLDERS

(more on page 11)



Brackets for Roll-Up Signs



Brackets for Rigid Signs

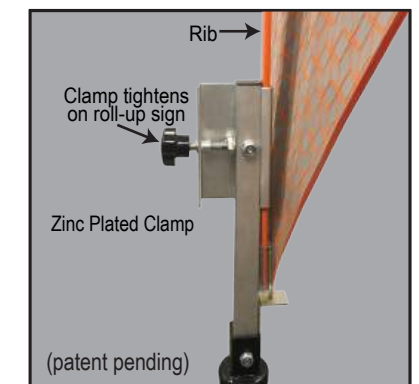

Compact Stands Universal Sign Clamp for Roll-Up Signs

COMPACT SPRINGLESS SIGN STANDS

- Holds roll-up signs 36" & 48"
 - universal compact sign clamp, zinc plated steel, grabs and tightens on roll-up rib
- Legs are extendable
- Non-skid rubber feet
- Replacement parts and assemblies available
- MASH Accepted for 48" roll-up signs, WZ-351
- Meets MUTCD Standards



No Spring

Model SS300



Model SS300A



Model #	Leg Material	Sign Mounting Height	Carton Size	Size Open Legs Collapsed Footprint	Size Open Legs Fully Extended Footprint	Weight	Sign Bracket
SS300	Orange Powder Coated Steel	13" from Ground Top of 48" sign - 82"H max.	7" x 7.5" x 25"	28" x 44"	40" x 65"	21 lbs.	Universal Roll-Up Sign Clamp Included Part # SA-URSHV4
SS300A	Aluminum					16 lbs.	

COMPACT SINGLE SPRING SIGN STANDS

- Holds roll-up signs 36" & 48"
 - universal compact sign clamp, zinc plated steel, grabs and tightens on roll-up rib
- Heavy duty steel spring
- Legs are extendable
- Non-skid rubber feet
- Replacement parts and assemblies available
- MASH Accepted
 - SS310 for 48" roll-up signs, WZ-352
 - SS310A for 48" roll-up signs, WZ-429
- Meets MUTCD Standards

Heavy Duty Single Spring



Model SS310



Model SS310A



Model #	Leg Material	Sign Mounting Height	Carton Size	Size Open Legs Collapsed Footprint	Size Open Legs Fully Extended Footprint	Weight	Sign Bracket
SS310	Orange Powder Coated Steel	13" from Ground Top of 48" sign - 82"H max.	7" x 7.5" x 25"	28" x 44"	40" x 65"	23 lbs.	Universal Roll-Up Sign Clamp Included Part # SA-URSHV4
SS310A	Aluminum					18 lbs.	

COMPACT DOUBLE SPRING SIGN STAND

Model SS340A

- Holds roll-up signs 36" & 48"
 - universal compact sign clamp, zinc plated steel, grabs and tightens on roll-up rib
- Heavy duty, steel double spring
- Legs are extendable
- Non-skid rubber feet
- Replacement parts and assemblies available
- MASH Accepted for 48" roll-up signs, WZ-353
- Meets MUTCD Standards

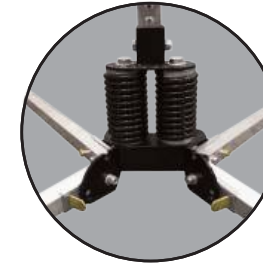

Heavy Duty Double Spring



Model #	Material	Sign Mounting Height	Carton Size	Size Open Legs Collapsed Footprint	Size Open Legs Fully Extended Footprint	Weight	Sign Bracket
SS340A	Aluminum	16" from Ground Top of 48" sign - 82"H max.	7.25" x 8.5" x 32.5"	38" x 55"	54" x 87"	27 lbs.	Universal Roll-Up Sign Clamp Included Part # SA-URSHV4

INTREPID™ RUBBER BASE SIGN STAND FOR ROLL-UP SIGNS

Model SSRB800

- Holds roll-up signs 36" & 48"
 - universal compact sign clamp, zinc plated steel, grabs and tightens on roll-up rib
- Designed for quick, easy sign relocation
 - clamp portion of post can be separated with sign attached
 - two carry handles
- Low profile and compact
 - great for narrow spaces, such as, bridge decks and sidewalks
- Heavy base stays in place
 - no need for additional ballast
- Post folds flat and locks for easy transport, storage, & stacking
 - foot release lever to initiate fold down
 - multiple stacking lugs on rubber base
- MASH Accepted for 48" roll-up signs, WZ-342
- Meets MUTCD Standards

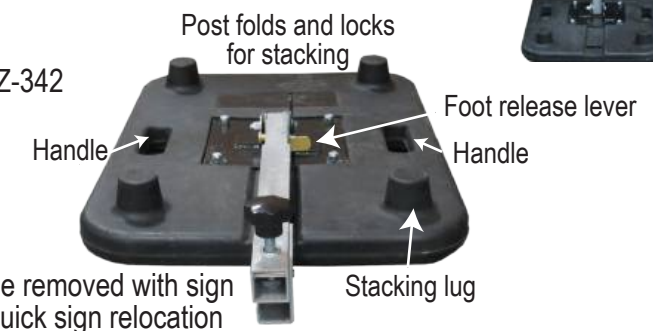

Sign clamp can be removed with sign attached for quick sign relocation

Model #	Material	Sign Mounting Height	Size Folded	Size Deployed	Weight	Sign Bracket
SSRB800	Rubber Base Steel Base Plate Aluminum Post	13" from Ground Top of 48" sign - 81"H max.	19"W x 31"D x 7"H	19"W x 26"D x 21.5"H	44 lbs.	Universal Roll-Up Sign Clamp Included Part # SA-USH

MEDIUM HEIGHT STEEL SPRINGLESS SIGN STAND FOR ROLL-UP SIGNS

Lightweight, Durable, & Economical Steel Sign Stand

- Holds roll-up signs 36" & 48"
 - accommodates 36" and 48" rigid signs
- Orange powder coated steel legs and mast, 26 lbs.
- Telescoping mast
- Fixed length legs
- Non-skid rubber feet
- Built-in three flag holder
- Small footprint enables more stands per truck
- Replacement parts and assemblies available
- Crash tested for MASH Acceptance, 48" roll-up sign at 60"
 - submitted to the FHWA
- Meets MUTCD Standards



Model #	Mast & Leg Material	Sign Mounting Height	Size Open Extended Footprint	Weight	Available Sign Brackets Purchase Separately		
SS400	Powder Coated Steel	60" from Ground Max. Height of Sign - 128"	40" x 84.5"	26 lbs.	Universal Roll-Up Sign Bracket #SH-RSMC-SM	Fast Bracket for Roll-Up Signs #SH-RMQR-SM	Rigid Sign Bracket #SH-HSHL-SM

MEDIUM HEIGHT ALUMINUM SPRINGLESS SIGN STAND FOR ROLL-UP SIGNS

- Holds roll-up signs 36" & 48"
- Telescoping mast
- Fixed length legs
- Non-skid rubber feet
- Built-in three flag holder
- Replacement parts and assemblies available
- MASH Accepted for 48" roll-up signs, WZ-354
- Meets MUTCD Standards

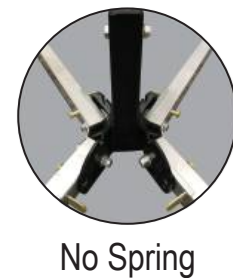
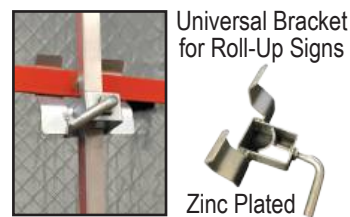

Model #	Mast & Leg Material	Sign Mounting Height	Carton Size	Size Open Legs Collapsed Footprint	Size Open Legs Fully Extended Footprint	Weight	Sign Bracket
SS410A	Aluminum	60" from Ground Max. Height of Sign - 128"	7" x 7.5" x 58.5"	Legs don't collapse	47" x 74"	19 lbs.	Universal Roll-Up Sign Bracket Included #SH-RSMC

HEAVY DUTY ALUMINUM DOUBLE SPRING SIGN STAND FOR RIGID SIGNS

- Holds rigid signs 36" & 48"
- Telescoping mast
- Heavy duty, double steel springs
- Fixed length legs, lock in multiple positions
- Non-skid rubber feet
- Built-in three flag holder
- Replacement parts and assemblies available
- MASH Accepted for 48"-.080 aluminum signs, WZ-355
- Meets MUTCD Standards



Model #	Mast & Leg Material	Sign Mounting Height	Carton Size	Size Open Legs Collapsed Footprint	Size Open Legs Fully Extended Footprint	Weight	Sign Brackets
SS420A	Aluminum	18" from Ground Top of 48" sign - 86"H max.	8.5" x 11.5" x 58.5"	Legs don't collapse	38" x 81"	36 lbs.	Rigid Brackets Included Bottom: #SH-HSHL Top: #SH-HSHL-08

HEAVY DUTY STEEL DOUBLE SPRING SIGN STAND

- Holds rigid and roll-up signs 36" & 48"
- Orange powder coated steel legs and mast, 39 lbs.
- Automotive grade steel, double spring
 - designed to perform in extreme weather conditions
 - E-coated for maximum rust and corrosion resistance
- Telescoping mast with fixed length legs
 - lock in multiple positions to adjust to uneven ground
- Non-skid rubber feet
- Built-in three flag holder
- Small footprint enables more stands per truck
- Replacement parts and assemblies available
- Crash tested for MASH Acceptance
 - 48" roll-up sign at 60" and 48"
 - .080 aluminum sign at 18"
 - submitted to the FHWA
- Meets MUTCD Standards

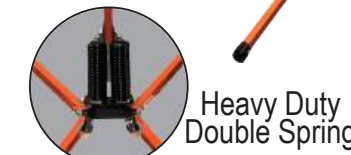

Model #	Mast & Leg Material	Sign Mounting Height	Carton Size	Size Open Legs Fully Extended Footprint	Weight	Available Sign Brackets Purchase Separately		
SS440	Powder Coated Steel	Roll-Up Sign: 60" from Ground Max. Height of Sign - 128" .080 Aluminum Sign: 18" from Ground Max. Height of Sign - 86"	40" x 84.5"	39 lbs.	Universal Roll-Up Sign Bracket #SH-RSMC-SM	Fast Bracket for Roll-Up Signs #SH-RMQR-SM	Rigid Sign Bracket #SH-HSHL-SM	

TALL DOUBLE SPRING SIGN STAND FOR CORRUGATED PLASTIC & ROLL-UP SIGNS

Model SS620A

- Holds rigid and roll-up signs 36" & 48"
- Telescoping mast
- Heavy duty, steel double spring
- Non-skid rubber feet
- Built-in heavy duty three flag holder - clamping type, holds flags in place
- Replacement parts and assemblies available
- MASH Accepted for 48" 10 mm corrugated plastic signs
 - mount rigid signs at 60" from ground, WZ-424
 - or 84" from the ground, WZ-425
- MASH Accepted for 48" roll-up signs
 - mount roll-up signs 84" from the ground, WZ-426
- Meets MUTCD Standards



Zinc Plated Universal Brackets
 Rigid Brackets: Top: SH-HSHL-96, Bottom: SH-HSL-95
 Roll-Up Bracket: SH-RSMC

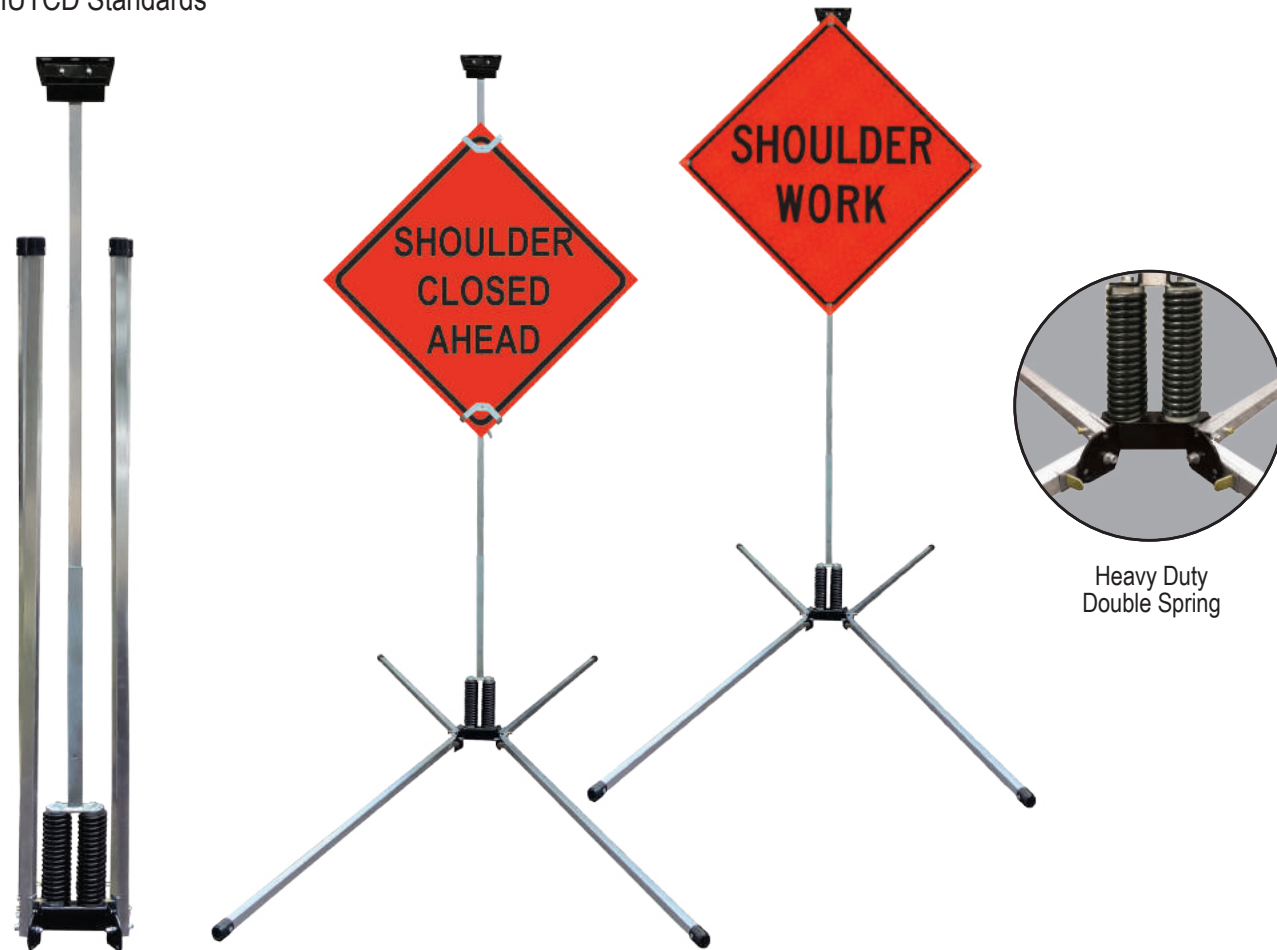

Model #	Mast & Leg Material	Sign Mounting Height	Carton Size	Legs Collapsed Footprint	Size Open Legs Fully Extended Footprint	Weight	Sign Brackets
SS620A	Aluminum	10 mm Corrugated Sign 60" from Ground Max. Height of Sign - 128"	9" x 12" x 72"	Legs don't collapse	56.44" x 130.6"	56 lbs.	No Brackets
SS620A-RG		10 mm Corrugated Sign 84" from Ground Max. Height of Sign - 152"				59.3 lbs.	Includes Rigid Brackets SH-HSL-95 (top) SH-HSHL-96 (bottom)
SS620A-RL		48" Roll-Up Sign 84" from Ground Max. Height of Sign - 152"				57 lbs.	Includes Roll-Up Sign Universal Bracket SH-RSMC
SS620A-FB						57 lbs.	Includes Fast Bracket for Roll-Up Signs SH-RMQR

TALL DOUBLE SPRING SIGN STAND FOR ALUMINUM SIGNS

Model SS621A

Mount Aluminum Signs 84" Above Ground!

- Holds rigid signs 36" & 48"
- Wind Sleeves™ increase stand stability with aluminum signs - patent pending
- Telescoping mast
- Heavy duty, steel double spring
- Non-skid rubber feet
- Built-in heavy duty three flag holder - clamping type, holds flags in place
- Replacement parts and assemblies available
- MASH Accepted for 48" .080 aluminum signs, WZ-427
 - mount rigid signs at 84" from the ground
- Meets MUTCD Standards



Bracket for Rigid Signs
 Zinc Plated
 (U.S. Patent 10,546,515)

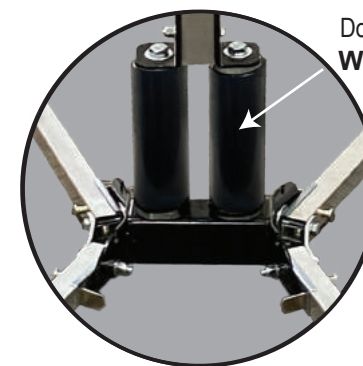

Heavy Duty Double Spring with Wind Sleeves™

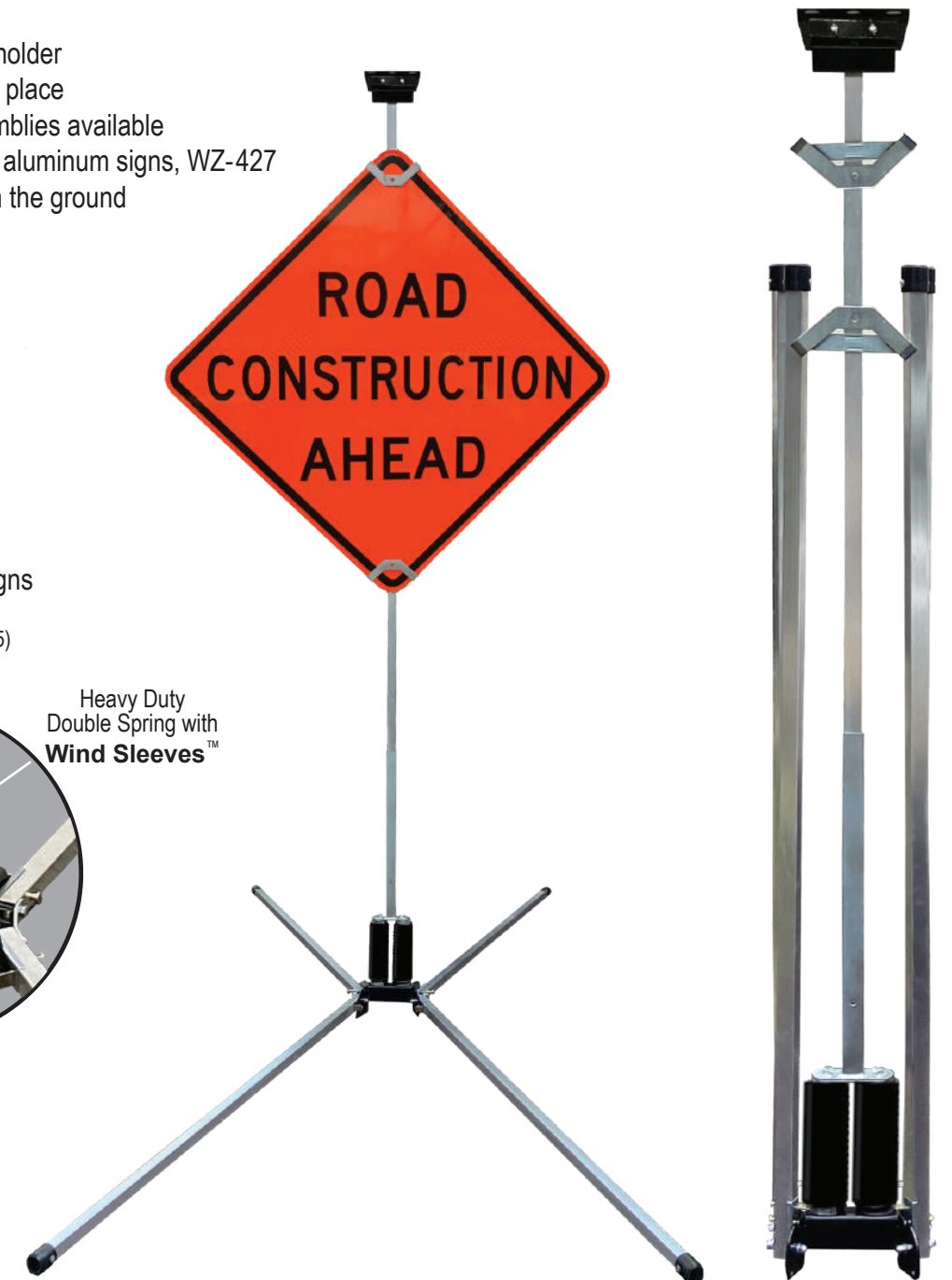

Model #	Mast & Leg Material	Sign Mounting Height	Carton Size	Size Open Legs Collapsed Footprint	Size Open Legs Fully Extended Footprint	Weight	Sign Brackets
SS621A	Aluminum	.080 Aluminum Sign 84" from Ground Max. Height of Sign - 152"	9" x 12" x 72"	Legs don't collapse	56.44" x 130.6"	56 lbs.	Includes Rigid Brackets SH-HSL-95 (top) SH-HSHL-96 (bottom)

TRIPOD SIGN STANDS

- Heavy duty stand for rigid signs, 36" & 48"
 - also holds roll-up signs (with a roll-up bracket)
- Extendable mast
- Fixed length legs
- Added safety feature eliminates pinch points
- Built-in three flag holder & sandbag hook
- MASH Accepted for 48" - 5/8" plywood signs, WZ-350
- Meets MUTCD Standards

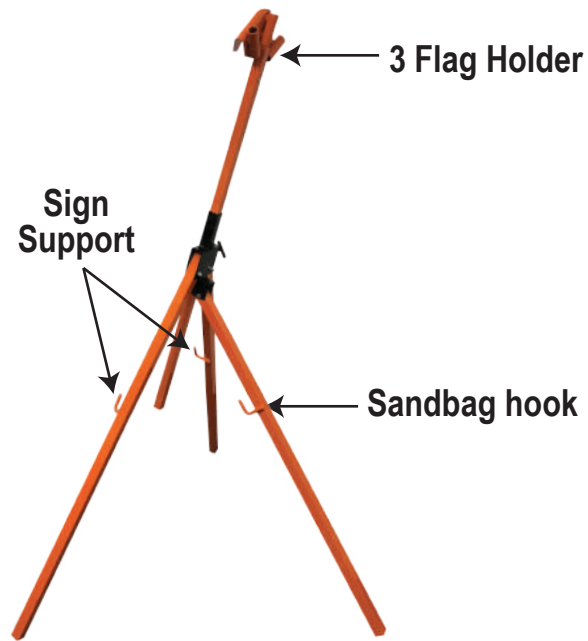

Model SS100



Model SS105

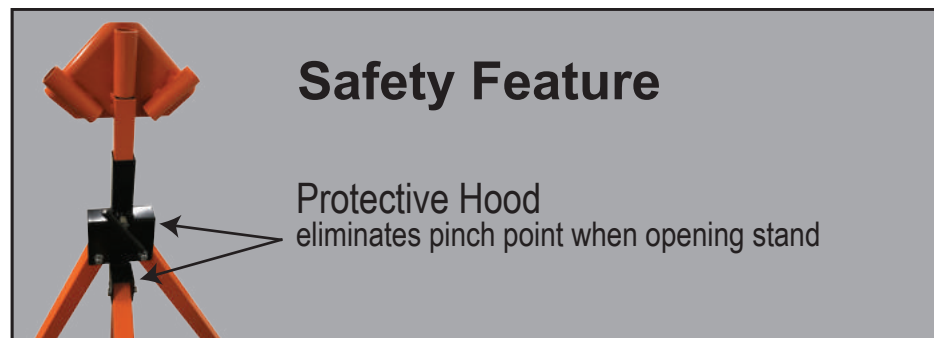

Model #	Material	Sign Mounting Height	Carton Size	Size Open Legs Collapsed Footprint	Size Open Legs Fully Extended Footprint	Weight	Brackets
SS100	Galvanized Steel	14" from Ground	4" x 7.5" x 51.5"	Legs don't collapse	30" x 49"	16 lbs.	Built in Rigid Sign Bracket
SS105	Orange Powder Coated Steel	Top of 48" sign - 81"H max.					

BARRIER MOUNT SIGN SUPPORT FOR ROLL-UP & RIGID SIGNS

- Use on highways with limited median & shoulder space
- Holds roll-up and rigid signs 48" or smaller
- Two clamp sizes, 12" & 15"
 - 12" fits 5.5" to 11.5" wide concrete barriers
 - 15" fits 8.5" to 15" wide concrete barriers
 - orange powder coated steel
- T-bolts (4 ea.) secure the sign support to the barrier
 - zinc plated hardened steel for maximum strength and wear resistance
- Double spring telescoping mast
 - can be offset on clamp for narrow shoulders
 - springs made of automotive grade steel
 - designed to perform in extreme weather conditions without fatiguing or breaking
 - e-coated for maximum rust and corrosion resistance
- Built-in heavy duty three flag holder
 - clamping type, holds flags in place
- Replacement parts and assemblies available

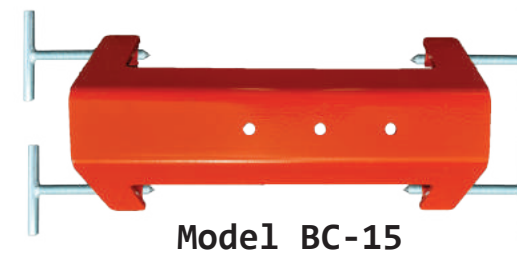
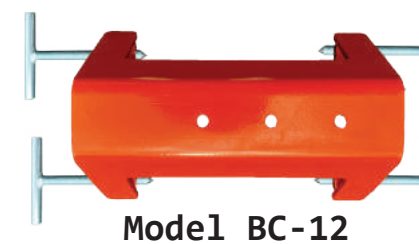

Easy assembly of mast to clamp with provided hardware.



Model #	Material	Size	Carton Size Clamp and Bracket(s)	Carton Size Mast	Weight	Sign Brackets
BC-12-1PK	Steel Clamp & T-bolts Only	Fits 5.5" to 11.5" wide concrete Jersey barriers	7.25" x 13.5" x 23.5"	none	18.3 lbs.	None
BC-12-RG-KIT	Steel Clamp, T-bolts, & Aluminum Mast	Fits 5.5" to 11.5" wide concrete Jersey barriers	7.25" x 13.5" x 23.5"	4" x 8.25" x 63"	40.3 lbs.	Includes Rigid Brackets SH-HSL-95 (2 ea.)
BC-12-FB-KIT					37.8 lbs.	Includes Fast Bracket for Roll-Up Signs SH-RMQR
BC-15-1PK	Steel Clamp & T-bolts Only	Fits 8.5" to 15" wide concrete Jersey barriers	7.25" x 13.5" x 23.5"	none	20.8 lbs.	None
BC-15-RG-KIT	Steel Clamp, T-bolts, & Aluminum Mast	Fits 8.5" to 15" wide concrete Jersey barriers	7.25" x 13.5" x 23.5"	4" x 8.25" x 63"	42.9 lbs.	Includes Rigid Brackets SH-HSL-95 (2 ea.)
BC-15-FB-KIT					40.4 lbs.	Includes Fast Bracket for Roll-Up Signs SH-RMQR

FOLDING FLAG ATTACHMENT

- Designed to permanently mount to roll-up sign
- 18" x 18" bright orange vinyl flags
- Riveted to roll-up cross brace through metal flag bracket
- ABS flag clips hold flags in open position
- Folds compactly for storage
- Fiberglass flag staffs, 14.4"L x 0.9"W x 0.11" thick

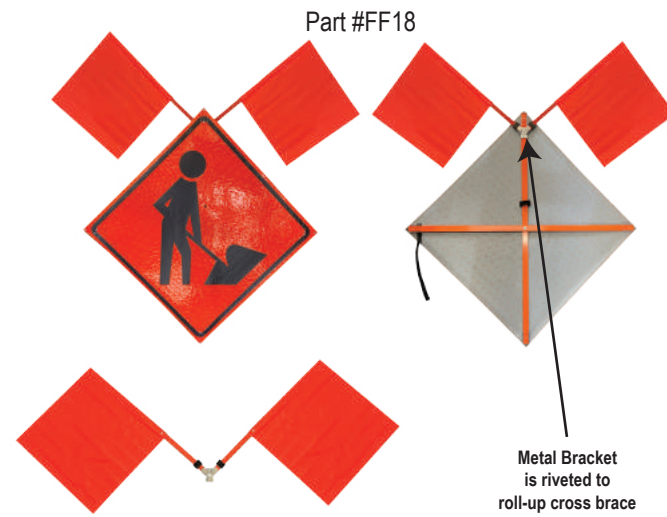

QUICK GRIP™ CLAMP

Comes Attached to Roll-Up Cross Brace For Fast Sign Deployment

- 3 rivets used to attach to horizontal cross brace
- Fits sign stand masts 3/4", 1", and 1 1/4" square tube
- Zinc plated

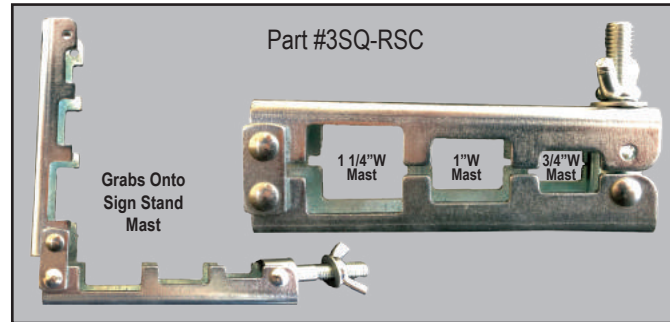

FAST BRACKET

- Quickly and securely attach roll-up signs to your sign stand
- Slide bracket onto mast and tighten using crank to keep in place
- Easy snap on design, pull back on handle to release
- Part #SH-RMQR-SM fits sign stand masts 3/4" to 1" (square tube)
- Part #SH-RMQR fits sign stand masts 1" to 1 1/2" (square tube)
- Zinc plated

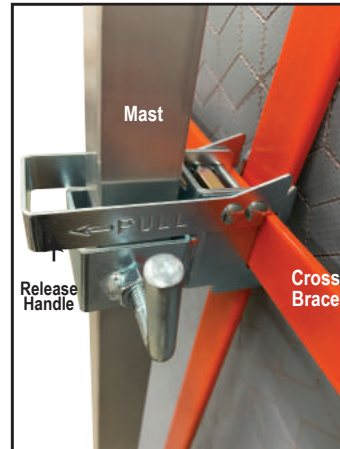
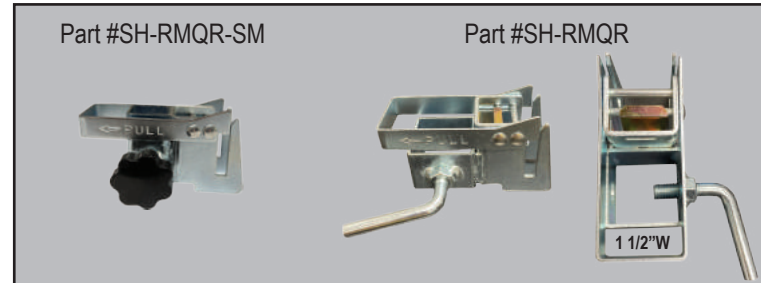

UNIVERSAL BRACKET FOR ROLL-UP SIGNS

- Part #SH-RSMC-SM fits sign stand masts 3/4" to 1" (square tube)
- Part #SH-RSMC fits sign stand masts 1" to 1 1/2" (square tube)
- Zinc plated

Use Roll-Up Clamps & Brackets With
SS400, SS410A, SS420A, SS440
SS620A, SS621A, BC-12, & BC-15

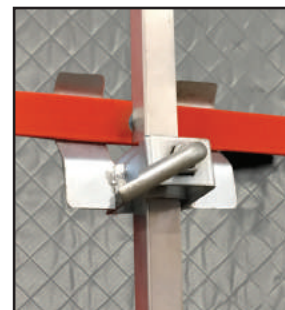

SNAP N PACK™ ROLL-UP SIGN

Sign folds up easily and snaps open.
Deploy in seconds on a compact sign stand.

- Wear Resistant Ink!
 - ink won't transfer to sign where it doesn't belong
- Roll-up Signs 36" & 48"
- Reflective in orange, yellow, and pink
- Non Reflective, orange
- Fiberglass Cross Braces
 - 3/8" Vertical Brace with 3/16" horizontal brace
- Durable Polycarbonate Corner Pockets
- Standard and Custom Legends Available

Perfect Product For
First Responders!

Sign Slides Onto
Universal Roll-Up

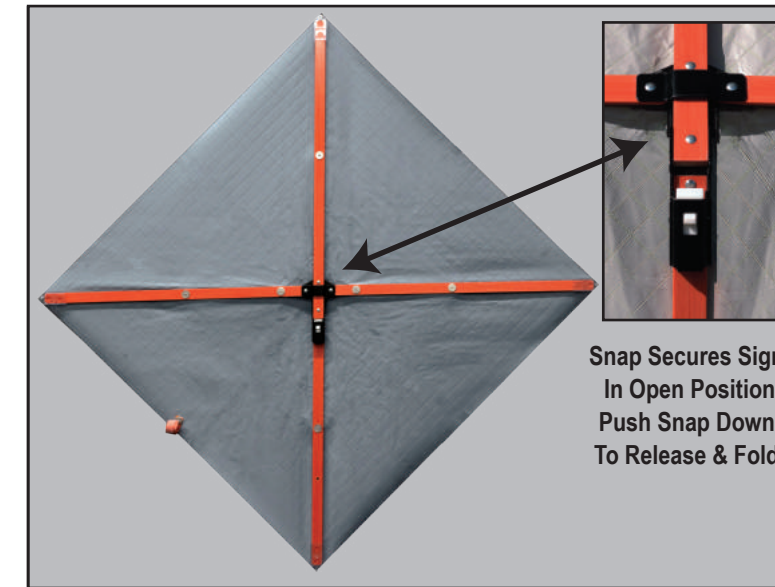
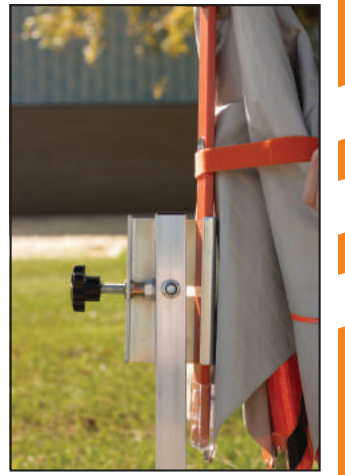

Carry Bags Available
Holds Sign Stand with
Snap N Pack Roll-Up Sign
attached and ready to deploy

- Use the Snap N Pack™ Roll-Up sign with our MASH Accepted Watchdog Compact Sign Stands
- Fits any stand with a universal roll-up sign bracket
 - Recommended Sign Stands
 - SS310A for 36" x 36" Signs
 - SS340A for 48" x 48" Signs



Optional Folding Flag Attachment

- Riveted to vertical brace
- Folds up with the sign for storage

HIGH QUALITY ROLL-UP SIGNS

Produced with State of the Art Printing

Wear Resistant Ink!

- Ink won't transfer to sign where it doesn't belong

Breakthrough Digital Print & Film Technology

- Reflective color performance exceeds ASTM D 4956 Type VI requirements

Standard & Custom Sign Sizes

Fiberglass Cross Braces

- Two thickness options
 - 1/4" Vertical Brace with 3/16" horizontal brace
 - 5/16" Vertical Brace with 3/16" horizontal brace

Anti-kiting Strap

- Sturdy hook & loop strap comes attached to sign
- Eliminates sail effect
 - backwind won't blow and move sign

Corner Pocket Options

- Durable polycarbonate plastic
- Sewn reinforced vinyl



Legend Identification

- Legend name printed on sign border on two edges
 - whichever way you roll it, it's easy to identify the sign legend

Storage Strap

- Hook & Loop nylon strap
 - secures the sign for storage

ROLL-UP SHEETING OPTIONS

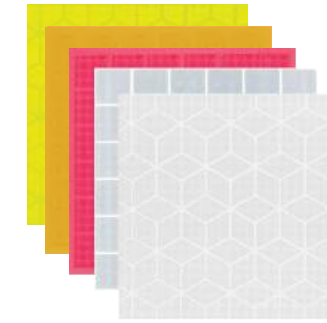

- MUTCD Non Reflective Vinyl
 - Fluorescent Orange
 - daytime use only, Meets ASTM D 4956 color
- Reflective Vinyl
 - 3M™ High Intensity Prismatic Grade, Vivid Orange Series RS30, Meets ASTM D4956 Type VI, CWZ
 - Oralite® Super Bright™ Vivid Orange, Fluorescent Pink White, & Yellow, Meets ASTM D 4956 Type VI, Class 5
- Avery Dennison® WU-7000
 - Fluorescent Orange, Fluorescent Pink, & White
 - Meets ASTM D 4956 Type VI, Class 5
- Oralite® High Performance Marathon
 - Fluorescent Orange, White, and Fluorescent Yellow/Green
 - Meets ASTM D 4956 Type VI, Class 5



Breakthrough Digital Print & Film Technology exceeds ASTM D 4956 Type VI





PLASTICADE[®]

Phone: (800) 772-0355

Plasticade.com



Distributed By:

A large, empty rectangular box with a black border, intended for a distributor's name or contact information.