



U.S. Department
of Transportation
**Federal Highway
Administration**

May 27, 2020

1200 New Jersey Ave., SE
Washington, D.C. 20590

In Reply Refer To:
HSST-1/WZ-406

Mr. Henry A. Ross
Plasticade
100 Howard Avenue
Des Plaines, IL 60018
USA

Dear Mr. Ross:

This letter is in response to your February 24, 2020 request for the Federal Highway Administration (FHWA) to review a roadside safety device, hardware, or system for eligibility for reimbursement under the Federal-aid highway program. This FHWA letter of eligibility is assigned FHWA control number WZ-406 and is valid until a subsequent letter is issued by FHWA that expressly references this device.

Decision

The following device is eligible within the length-of-need, with details provided in the form which is attached as an integral part of this letter:

- Plasticade® Combocade® Type I and Type II Barricade

Scope of this Letter

To be found eligible for Federal-aid funding, new roadside safety devices should meet the crash test and evaluation criteria contained in the American Association of State Highway and Transportation Officials' (AASHTO) Manual for Assessing Safety Hardware (MASH). However, the FHWA, the Department of Transportation, and the United States Government do not regulate the manufacture of roadside safety devices. Eligibility for reimbursement under the Federal-aid highway program does not establish approval, certification or endorsement of the device for any particular purpose or use.

This letter is not a determination by the FHWA, the Department of Transportation, or the United States Government that a vehicle crash involving the device will result in any particular outcome, nor is it a guarantee of the in-service performance of this device. Proper manufacturing, installation, and maintenance are required in order for this device to function as tested.

This finding of eligibility is limited to the crashworthiness of the system and does not cover other structural features, nor conformity with the Manual on Uniform Traffic Control Devices.

Eligibility for Reimbursement

Based solely on a review of crash test results and certifications submitted by the manufacturer, and the crash test laboratory, FHWA agrees that the device described herein meets the crash test and evaluation criteria of the AASHTO's MASH. Therefore, the device is eligible for reimbursement under the Federal-aid highway program if installed under the range of tested conditions.

Name of system: Plasticade® Combocade® Type I and Type II Barricade
Type of system: Work Zone
Test Level: MASH Test Level 3 (TL3)
Testing conducted by: Texas A&M Transportation Institute (TTI).
Date of request: February 24, 2020

FHWA concurs with the recommendation of the accredited crash testing laboratory on the attached form.

Full Description of the Eligible Device

The device and supporting documentation, including reports of the crash tests or other testing done, videos of any crash testing, and/or drawings of the device, are described in the attached form.

Notice

This eligibility letter is issued for the subject device as tested. Modifications made to the device are not covered by this letter. Any modifications to this device should be submitted to the user (i.e., state DOT) as per their requirements.

You are expected to supply potential users with sufficient information on design, installation and maintenance requirements to ensure proper performance.

You are expected to certify to potential users that the hardware furnished has the same chemistry, mechanical properties, and geometry as that submitted for review, and that it will meet the test and evaluation criteria of AASHTO's MASH.

Issuance of this letter does not convey property rights of any sort or any exclusive privilege. This letter is based on the premise that information and reports submitted by you are accurate and correct. We reserve the right to modify or revoke this letter if: (1) there are any inaccuracies in the information submitted in support of your request for this letter, (2) the qualification testing was flawed, (3) in-service performance or other information reveals safety problems, (4) the system is significantly different from the version that was crash tested, or (5) any other information indicates that the letter was issued in error or otherwise does not reflect full and complete information about the crashworthiness of the system.

Standard Provisions

- To prevent misunderstanding by others, this letter of eligibility designated as FHWA control number WZ-406 shall not be reproduced except in full. This letter and the test documentation upon which it is based are public information. All such letters and documentation may be reviewed upon request.
- This letter shall not be construed as authorization or consent by the FHWA to use, manufacture, or sell any patented system for which the applicant is not the patent holder.
- This FHWA eligibility letter is not an expression of any Agency view, position, or determination of validity, scope, or ownership of any intellectual property rights to a specific device or design. Further, this letter does not impute any distribution or licensing rights to the requester. This FHWA eligibility letter determination is made based solely on the crash-testing information submitted by the requester. The FHWA reserves the right to review and revoke an earlier eligibility determination after receipt of subsequent information related to crash testing.

Sincerely,

A handwritten signature in blue ink that reads "Michael S. Griffith". The signature is written in a cursive style.

Michael S. Griffith
Director, Office of Safety Technologies
Office of Safety

Enclosures

Request for Federal Aid Reimbursement Eligibility of Highway Safety Hardware

Submitter	Date of Request:	February 24, 2020	<input checked="" type="radio"/> New <input type="radio"/> Resubmission
	Name:	Henry A. Ross	
	Company:	Plasticade	
	Address:	100 Howard Avenue, DesPlaines, IL 60018	
	Country:	U.S.A.	
To:	Michael S. Griffith, Director FHWA, Office of Safety Technologies		

I request the following devices be considered eligible for reimbursement under the Federal-aid highway program.

Device & Testing Criterion - Enter from right to left starting with Test Level

!-!-!

!-!-!

System Type	Submission Type	Device Name / Variant	Testing Criterion	Test Level
'WZ':Crash Worthy Work Zone	<input checked="" type="radio"/> Physical Crash Testing <input type="radio"/> Engineering Analysis	Plasticade®Combocade® Type I and Type II Barricade	AASHTO MASH	TL3

By submitting this request for review and evaluation by the Federal Highway Administration, I certify that the product(s) was (were) tested in conformity with the AASHTO Manual for Assessing Safety Hardware and that the evaluation results meet the appropriate evaluation criteria in the MASH.

Individual or Organization responsible for the product:

Contact Name:	Henry A. Ross	Same as Submitter <input checked="" type="checkbox"/>
Company Name:	Plasticade	Same as Submitter <input checked="" type="checkbox"/>
Address:	100 Howard Avenue, DesPlaines, IL 60018	Same as Submitter <input checked="" type="checkbox"/>
Country:	U.S.A.	Same as Submitter <input checked="" type="checkbox"/>

Enter below all disclosures of financial interests as required by the FHWA 'Federal-Aid Reimbursement Eligibility Process for Safety Hardware Devices' document.

Texas A&M Transportation Institute (TTI) was contracted by Plasticade® to perform full-scale crash testing of the Plasticade®Combocade®. There are no shared financial interests in the Plasticade®Combocade® by TTI, or between Plasticade® and TTI, other than costs involved in the actual crash tests and reports for this submission to FHWA.

690900-PLP1&2

PRODUCT DESCRIPTION

Help

- New Hardware or Significant Modification
 Modification to Existing Hardware

The Combocade® Type I and Type II barricade is 42.3 inches tall, 24 inches wide, and 31 inches long. The barricade stands on 45-inch long 14-gauge galvanized steel angle legs. All boards used are made from HDPE (high density polyethylene plastic). Each top board measured 12 inches × 24 inches × 0.6 inch thick. Each bottom board measured 6 inches × 24 inches × 0.6 inch thick. A safety light (Empco-Lite Model 2006 with four D-cell batteries) was attached to the top of the test article, bringing total height of the barricade to 49.8 inches to the top of the safety light. The test article weighed 20 lb (including the 3-lb safety light), and a 35-lb sand bag was placed over one of the bottom boards.

CRASH TESTING

By signature below, the Engineer affiliated with the testing laboratory, agrees in support of this submission that all of the critical and relevant crash tests for this device listed above were conducted to meet the MASH test criteria. The Engineer has determined that no other crash tests are necessary to determine the device meets the MASH criteria.

Engineer Name:	D. Lance Bullard, Jr., P.E.		
Engineer Signature:	D. Lance Bullard, Jr.	Digitally signed by D. Lance Bullard, Jr. Date: 2020.03.02 08:31:43-06'00'	
Address:	3100 SH 47, Bldg 7091, Bryan, TX, 77807	Same as Submitter	<input type="checkbox"/>
Country:	U.S.A.	Same as Submitter	<input type="checkbox"/>

A brief description of each crash test and its result: Help

Required Test Number	Narrative Description	Evaluation Results
3-70 (1100C)	<p>MASH states that Test 3-70 for small vehicles is considered optional for work-zone traffic control devices weighing less than 220 lb, because velocity changes during low-speed impacts with free-standing, lightweight features will be within acceptable limits. The Plasticade® Combocade® Type I and Type II Barricade traffic control device weighed approximately 20 pounds each, exclusive of the sandbags. Therefore, MASH Test 3-70 was not performed on this traffic control device.</p>	Non-Critical, not conducted

Required Test Number	Narrative Description	Evaluation Results
3-71 (1100C)	<p>MASH Test 3-71 involved an 1100C vehicle weighing 2420 lb ±55 lb impacting the traffic control device at an impact speed of 62 mi/h ±2.5 mi/h. Per MASH recommendations, the device was tested at critical impact angles (CIAs) of 90° ±1.5° and 0° ±1.5°.</p> <p>The results of test 690900-PLP1 conducted on October 21, 2019 are found in TTITest Report number 690900-PLP1&2. The test vehicle was traveling at an impact speed of 63.9 mi/h when it contacted the first barricade at an impact angle of 0°. The vehicle was traveling at an impact speed of 62.9 mi/h and impact angle of 90° when it contacted the second barrier. Brakes on the vehicle were applied after loss of contact with the second barricade, and the vehicle came to rest 326 ft downstream of the impact point with the first barricade. One of the panels from the first barricade came to rest 45 ft downstream of impact and 28 ft to the right of centerline of the vehicle path, and the remainder of the barricade was deformed but intact and came to rest 163 ft downstream and 15 ft to the left of centerline of the vehicle path. The second barricade was deformed, but all components remained together and it came to rest 118 ft downstream and 32 ft to the right of centerline of the vehicle path. The front bumper, air dam, and lower radiator support were damaged. The hood sustained three deformation areas; one measured 11 inches × 17 inches × 0.75 inch deep, another 8 inches × 10 inches × 0.25 inch deep, and the third 8 inches × 6 inches × 0.25 inch deep. There was no damage to the windshield. Maximum exterior crush to the vehicle was 0.75 inch in the front plane on the hood. No occupant compartment deformation or intrusion was observed.</p> <p>MASH does not require instrumentation of the vehicle when impacting lightweight, freestanding work zone traffic control devices weighing less than 220 lb, therefore the occupant risk factors were not calculated for this test. The Plasticade® Combocade® Type I and Type II Barricade weighed approximately 20 lb each, exclusive of the sandbags.</p> <p>The Combocade® performed acceptably for MASH test 3-71 with impact angles of 0° and 90°.</p>	PASS

3-72 (2270P)	<p>MASH Test 3-72 involves a 2270P vehicle weighing 5000 lb \pm 110 lb impacting the traffic control device at an impact speed of 62 mi/h \pm 2.5 mi/h. Per MASH recommendations, the device was tested at critical impact angles (CIAs) of 90° \pm 1.5° and 0° \pm 1.5°.</p> <p>The results of test 690900-PLP2 conducted on October 21, 2019 are found in TTITest Report number 690900-PLP1&2. The test vehicle was traveling at an impact speed of 63.9 mi/h when it contacted the first barricade at an impact angle of 0°. The vehicle was traveling at an impact speed of 61.7 mi/h and impact angle of 90° when it contacted the second barrier. Brakes on the vehicle were applied after loss of contact with the second barricade, and the vehicle came to rest 372 ft downstream of the impact point with the first barricade and 12 ft left of centerline of the vehicle path. The first barricade fractured into two pieces. One piece of the first barricade came to rest 60 ft downstream of impact and in the centerline of the vehicle path, and the remainder of the barricade came to rest 65 ft downstream and 4 ft to the left of centerline of the vehicle path. The second barricade fractured into several pieces, the majority of which came to rest 200 ft downstream and in the centerline of the vehicle path. The hood sustained two small deformation areas that were so slight as to be insignificant. There was no damage to the windshield. No occupant compartment deformation or intrusion was observed.</p> <p>MASH does not require instrumentation of the vehicle when impacting lightweight, freestanding work zone traffic control devices weighing less than 220 lb, therefore the occupant risk factors were not calculated for this test. The Plasticade® Combocade® Type I and Type II Barricade weighed approximately 20 lb each, exclusive of the sandbags. The Combocade® performed acceptably for MASH test 3-72 with impact angles of 0° and 90°.</p>	PASS
--------------	---	------

Full Scale Crash Testing was done in compliance with MASH by the following accredited crash test laboratory (cite the laboratory's accreditation status as noted in the crash test reports.):

Laboratory Name:	TexasA&M Transportation Institute	
Laboratory Signature:	Digitally signed by Darrell L. Kuhn 'Date: 2020.02.28 16:31:33 -06'00' 	
Address:	3100SH47, Bldg 7091, Bryan, TX, 77807	SameasSubmitter <input type="checkbox"/>
Country:	U.S.A	SameasSubmitter <input type="checkbox"/>
Accreditation Certificate Number and Dates of current Accreditation period :	ISO 17025-2017 Laboratory A2LA Certificate Number: 2821.01 Valid To: April 30, 2021	

SubmitterSignature*: **Henry Ross** Digitally signed by Henry Ross
Date: 2020.03.03 16:10:08
-06'00'

Submit Form

ATTACHMENTS

Attach to this form:

- 1) Additional disclosures of related financial interest as indicated above.
- 2) A copy of the full test report, video, and a Test Data Summary Sheet for each test conducted in support of this request.
- 3) A drawing or drawings of the device(s) that conform to the Task Force-13 Drawing Specifications [[Hardware Guide Drawing Standards](#)]. For proprietary products, a single isometric line drawing is usually acceptable to illustrate the product, with detailed specifications, intended use, and contact information provided on the reverse. Additional drawings (not in TF-13 format) showing details that are relevant to understanding the dimensions and performance of the device should also be submitted to facilitate our review.

FHWA Official Business Only:

Eligibility Letter		
Number	Date	Key Words

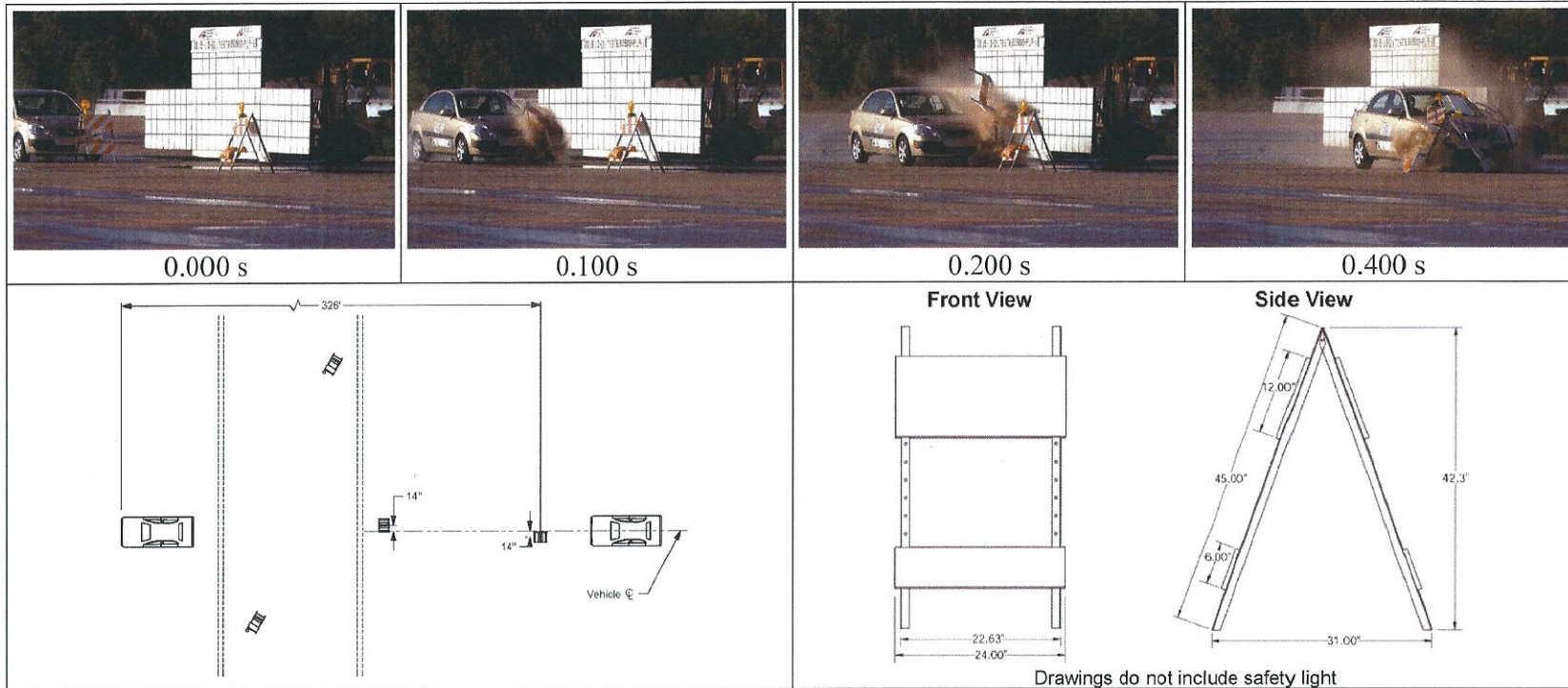

General Information

Test Agency Texas A&M Transportation Institute (TTI)
 Test Standard Test No. MASH Test 3-71 at 0° and 90°
 TTI Test No. 690900-PLP1
 Test Date 2019-10-21

Test Article

Type Work-Zone Traffic Control Device -
 Type I and Type II Barricade
 Name Plasticade® Combocade®
 Installation Height/Weight ... 49.8 inches / 20 lb (both include light)
 Material or Key Elements ... 45-inch long steel angle legs, HDPE
 boards, safety light, and one 35-lb sand
 bag

Soil Type and Condition Concrete pavement, damp

Test Vehicle

Type/Designation 1100C
 Make and Model 2008 Kia Rio
 Curb 2343 lb
 Test Inertial 2430 lb
 Dummy 165 lb
 Gross Static 2595 lb

Impact Conditions

Speed Barricade #1 63.9 mi/h
 Angle Barricade #1 0°
 Speed Barricade #2 62.9 mi/h
 Angle Barricade #2 90°
 Kinetic Energy #1 & #2 332 & 321 kip-ft

Exit Conditions

Speed Barricade #1 62.9 mi/h
 Speed Barricade #2 61.0 mi/h

Post-Impact Trajectory

Stopping Distance 326 ft downstream

Maximum Test Debris Scatter

Barricade #1 163 ft downstream
 15 ft left/28 ft right
 Barricade #2 118 ft downstream
 32 ft right

Vehicle Damage

VDS 12FD1
 CDC 12FDEN1
 Max. Exterior Deformation 0.75 inch
 OCDI FS0000000
 Max. Occupant Compartment
 Deformation None
 Windshield Damage None

Figure 5.7. Summary of Results for MASH Test 3-71 at 0° and 90° on Plasticade® Combocade®.

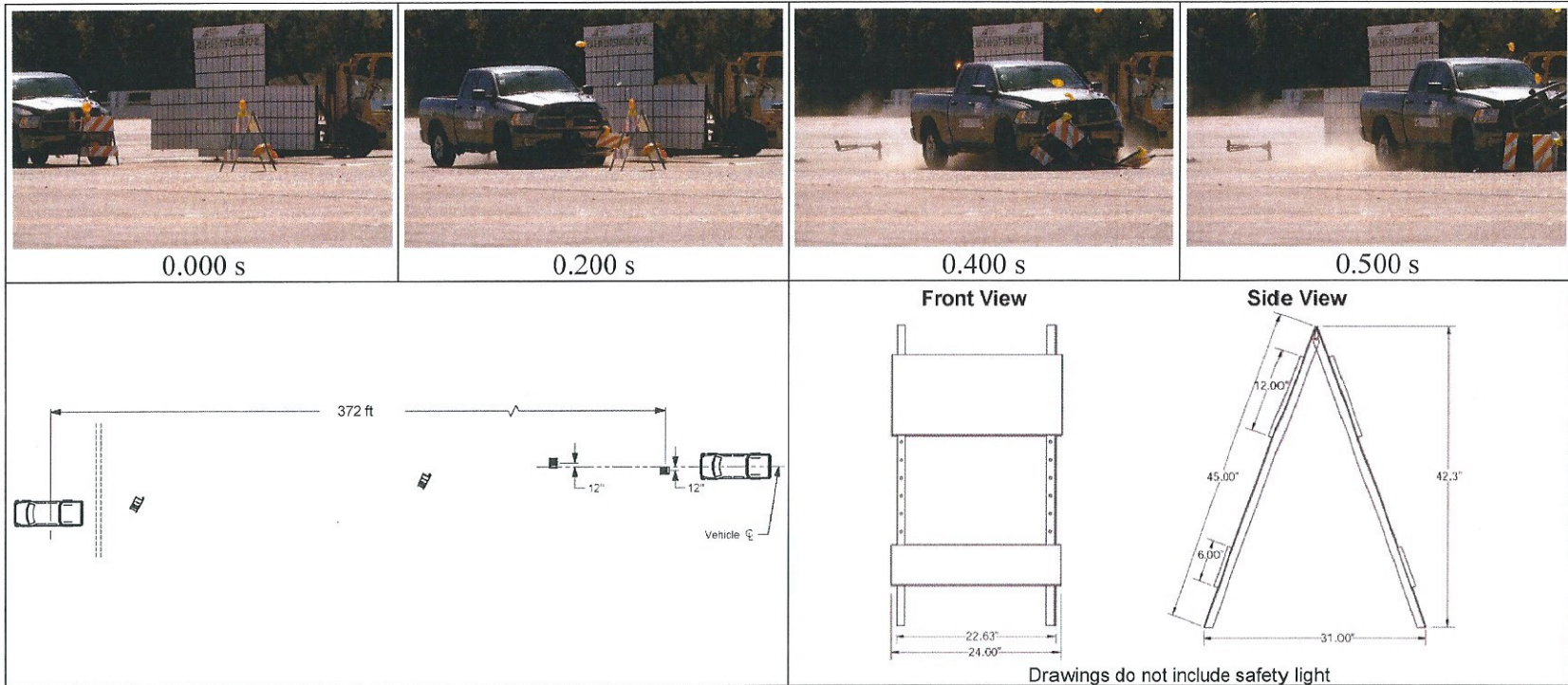

General Information

Test Agency Texas A&M Transportation Institute (TTI)
 Test Standard Test No. MASH Test 3-72 at 0° and 90°
 TTI Test No. 690900-PLP2
 Test Date 2019-10-21

Test Article

Type Work-Zone Traffic Control Device -
 Type I and Type II Barricade
 Name Plasticade® Combocade®
 Installation Height/Weight ... 49.8 inches / 20 lb (both include light)
 Material or Key Elements ... 45-inch long steel angle legs, HDPE
 boards, safety light, and one 35-lb sand
 bag

Soil Type and Condition Concrete pavement, damp

Test Vehicle

Type/Designation 2270P
 Make and Model 2013 RAM 1500
 Curb 4988 lb
 Test Inertial 5030 lb
 Dummy No dummy
 Gross Static 5030 lb

Impact Conditions

Speed Barricade #1 63.9 mi/h
 Angle Barricade #1 0°
 Speed Barricade #2 61.7 mi/h
 Angle Barricade #2 90°

Kinetic Energy #1 & #2 687 & 640 kip-ft

Exit Conditions

Speed Barricade #1 61.7 mi/h
 Speed Barricade #2 59.7 mi/h

Post-Impact Trajectory

Stopping Distance 372 ft downstream
 12 ft left

Maximum Test Debris Scatter

Barricade #1 65 ft downstream
 4 ft left
 Barricade #2 200 ft downstream
 12 ft left

Vehicle Damage

VDS 12FD1
 CDC 12FDEW1
 Max. Exterior Deformation None measurable
 OCDI FS0000000
 Max. Occupant Compartment
 Deformation None
 Windshield Damage None

Figure 6.7. Summary of Results for MASH Test 3-72 at 0° and 90° on Plasticade® Combocade®.

COMBOCADE™

TYPE I & TYPE II BARRICADE

Front View

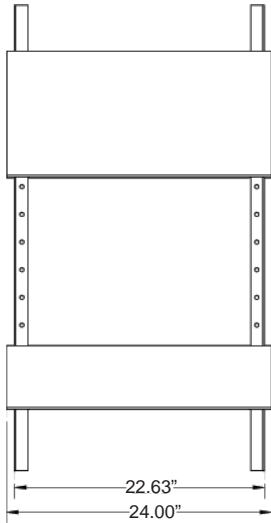

Side View

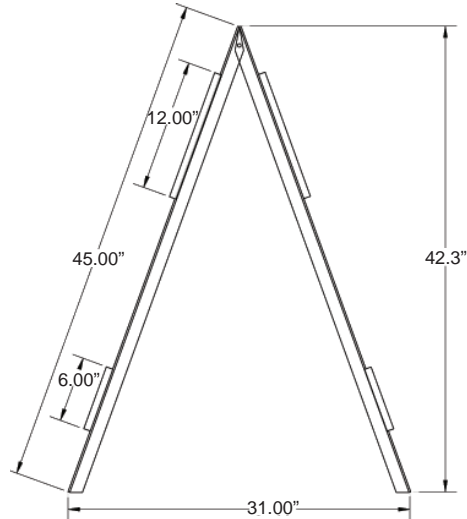

Specs

Dimensions	45"H x 24"W x 2 1/2"D
Leg Composition	Roll Formed Steel, Galvanized, white powder coated by special order
Leg Weight	2.2 lbs.
Leg Thickness	14 gauge - 1 1/4"
Board Composition	High Density Polyethylene
Board Sizes	12"H x 24"W - 1.6 lbs. 8"H x 24"W - 1.4 lbs. 6"H x 24"W - 1 lb.
Board Thickness	5/8" D
Board Color	White
Reflective Sheeting	Available in all grades in white and orange stripes

24"W x 12"H Board

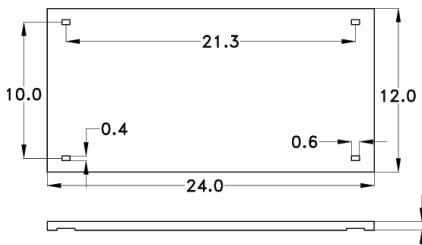

24"W x 8"H Board

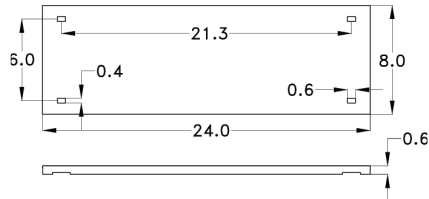

24"W x 6"H Board

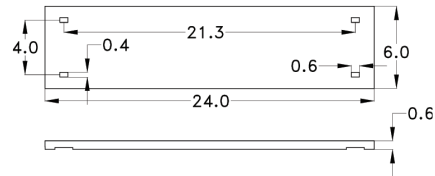

Back of Board

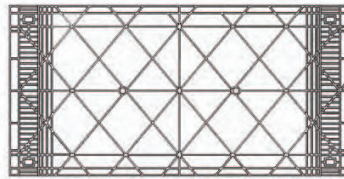

PLASTICADE®

7700 N. Austin Avenue
Skokie, IL 60077
phone (800) 772-0355
fax (847) 966-8074

www.plasticade.com



MADE IN THE USA