

MEDIUM HEIGHT SPRINGLESS SIGN STAND FOR ROLL-UP SIGNS

**MASH
APPROVED**



Model SS410A



No Spring



- Holds roll-up signs 36" & 48"
- Telescoping mast
- Fixed length legs
 - lock in multiple positions to adjust to uneven ground
- Non-skid rubber feet
- Built-in three flag holder
- Replacement parts and assemblies available
- MASH Accepted for 48" roll-up signs, WZ-354
- Meets MUTCD Standards

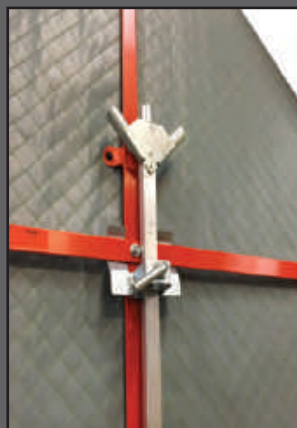

Universal Bracket
for Roll-Up Signs



Zinc Plated

PLASTICADE®

Plasticade.com

TF054 Rev. 3

MEDIUM HEIGHT SPRINGLESS SIGN STAND FOR ROLL-UP SIGNS

Specs

Material Model SS410A	Aluminum
Sign Mounting Height	60" from ground
Top of 48" Sign	128" H maximum
Carton Size	7" x 7.5" x 58.5"
Size Open legs collapsed footprint	legs don't collapse
Size Open legs fully extended footprint	47" x 74"
Weight	19 lbs.
Included Bracket	Universal Roll-Up Sign Bracket

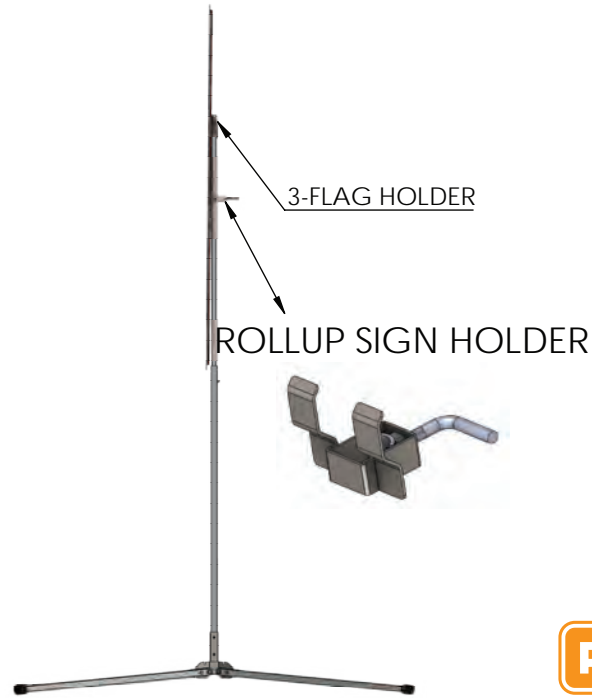
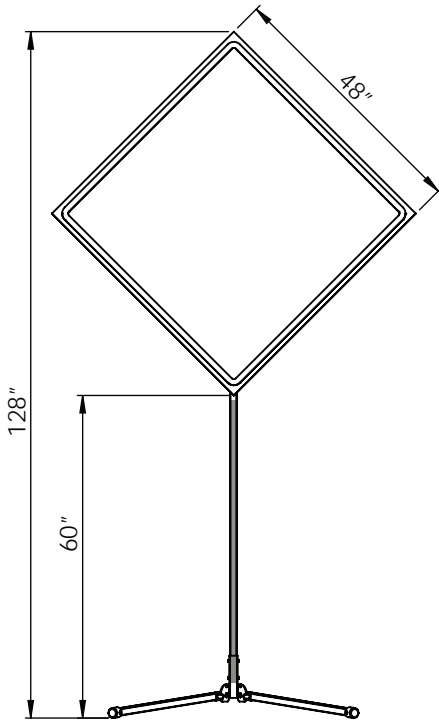
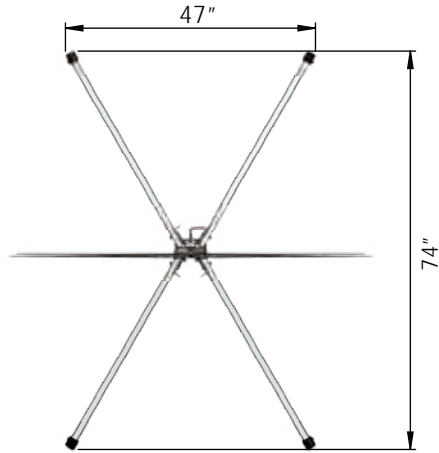

LEG RELEASE SYSTEM

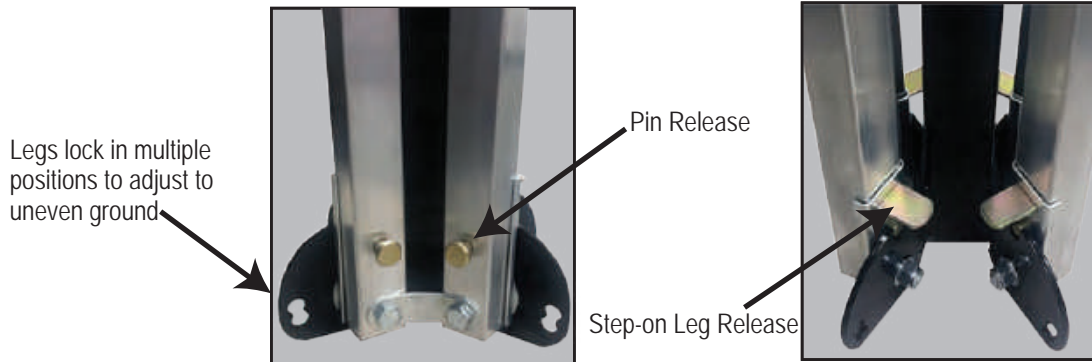

100 Howard Avenue
Des Plaines, IL 60018
phone (800) 772-0355
fax (847) 966-8074

Plasticade.com