

# AVALON

## CROWD CONTROL BARRIER

high visibility barrier  
with anti-trip feet



- Linking design creates secure, tamper free, connections
  - units adjust to uneven ground
- High visibility, anti-trip feet
- Panels on both sides for retroreflective sheeting
- Holes for signs to be affixed
- Durable polyethylene
- Available in orange, yellow, white, and blue



Avalon adjusts to uneven ground



**PLASTICADE®**

[www.plasticade.com](http://www.plasticade.com) TF027

# AVALON

## CROWD CONTROL BARRIER

Specs	
Composition	Polyethylene
Weight	24 lbs.
Colors	Orange, Yellow, White, & Blue
Sheeting Area	5.5" x 51" on each side
Retroreflective Sheeting	Striped sheeting in engineer grade or high intensity prismatic grade

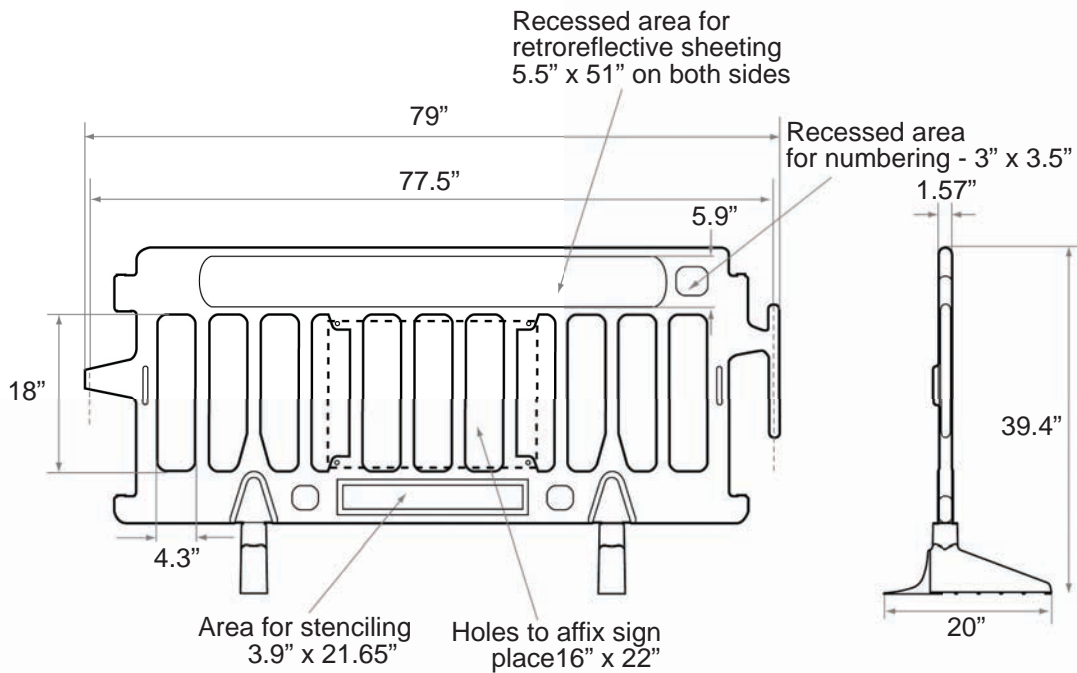

### Various Barrier Configurations

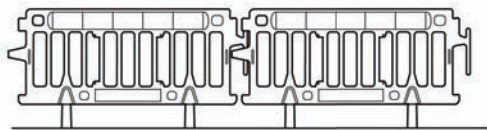

Locked

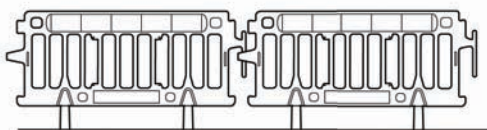

Unlocked

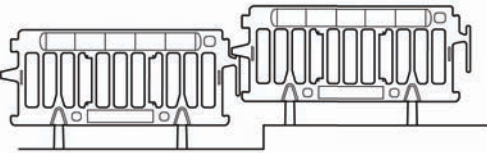

Curb

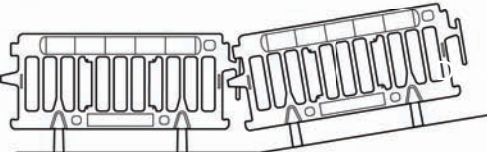

Uphill Slope

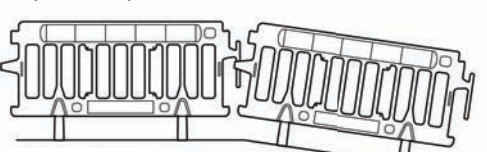

Downhill Slope

3 barriers unlocked extend 232.5"  
3 barriers locked extend 221.7"

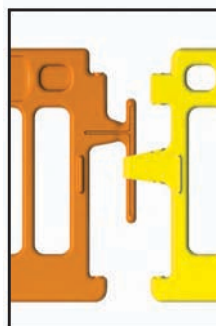

connected unlocked



lift one barrier to lock

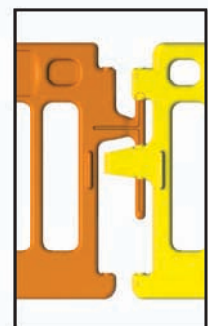

connected locked

**PLASTICADE®**

7700 N. Austin Avenue  
Skokie, IL 60077  
phone (800) 772-0355  
fax (847) 966-8074

[www.plasticade.com](http://www.plasticade.com)